

**Vecow Co.,Ltd.**

# TEST REPORT

**REPORT NUMBER**  
200500247TWN-001

**ISSUE DATE**  
Jun. 16, 2020

**PAGES**  
68

© 2020 INTERTEK



# EMC TEST REPORT

<b>Applicant:</b>	<b>Vecow Co.,Ltd.</b> <b>3F, No. 10, Jiankang Rd., Zhonghe Dist., New Taipei City, Taiwan</b>
<b>Product:</b>	<b>MTC-7000 Series Multi-touch panel pc</b>
<b>Model No.:</b>	<b>MTC-7XXX-XXX, MTC-7010W</b>
<b>Brand Name:</b>	<b>Vecow</b>
<b>Test Method/ Standard:</b>	<b>EN 55032: 2015/AC:2016</b> <b>EN IEC 61000-3-2: 2019</b> <b>EN 61000-3-3: 2013+A1: 2019</b> <b>EN 55035: 2017</b>
<b>Test By:</b>	<b>Intertek Testing Services Taiwan Ltd.,</b> <b>Hsinchu Laboratory</b> <b>No. 11, Lane 275, Ko-Nan 1 Street, Chia-Tung Li,</b> <b>Shiang-Shan District, Hsinchu City, Taiwan</b>



Prepared and Checked by:

Handwritten signature of Alan Wu in black ink.

---

Alan Wu  
Engineer

Approved by:

Handwritten signature of Lion Chiu in black ink.

---

Lion Chiu  
Group Leader

This report is for the exclusive use of Intertek's Client and is provided pursuant to the agreement between Intertek and its Client. Intertek's responsibility and liability are limited to the terms and conditions of the agreement. Intertek assumes no liability to any party, other than to the Client in accordance with the agreement, for any loss, expense or damage occasioned by the use of this report. Only the Client is authorized to permit copying or distribution of this report and then only in its entirety. Any use of the Intertek name or one of its marks for the sale or advertisement of the tested material, product or service must first be approved in writing by Intertek. The observations and test results in this report are relevant only to the sample tested. This report by itself does not imply that the material, product, or service is or has ever been under an Intertek certification program.

**Revision History**

<b>Report No.</b>	<b>Issue Date</b>	<b>Revision Summary</b>
200500247TWN-001	Jun. 16, 2020	Original report

## Table of Contents

1. General Information .....	6
1.1 Identification of the EUT .....	6
1.2 Adapter information .....	6
1.3 Additional information about the EUT .....	6
2. Test Summary .....	7
3. Test Specifications .....	8
3.1 Standards .....	8
3.2 Test Facility accreditation .....	8
3.3 Classification of MME .....	9
3.4 Performance criteria .....	9
3.5 Mode of operation during the test .....	10
3.6 Peripherals equipment .....	10
4. Conducted Emission Test .....	11
4.1 Test Procedure .....	11
4.2 Test Equipment .....	12
4.3 Conducted Emission Limit .....	12
4.4 Conducted Emission Data .....	13
4.5 Telecommunication Port Emission Test .....	15
4.5.1 Test Procedure .....	15
4.5.2 Test Equipment .....	15
4.5.3 Limits of conducted common mode (asymmetric mode) disturbance at telecommunication ports .....	16
4.5.4 Telecommunication Port Emission Data .....	17
5. Radiated Emission Test .....	18
5.1.1 Test Procedure from 30 MHz to 1000 MHz .....	18
5.1.2 Test Equipment .....	19
5.1.3 Radiated Emission Limit .....	20
5.1.4 Radiated Emission Test Data from 30 MHz to 1000 MHz .....	21
5.2.1 Test Procedure above 1 GHz .....	23
5.2.2 Test Equipment .....	24
5.2.3 Radiated Emission Limit .....	24
5.2.4 Radiated Emission Test Data above 1 GHz .....	25
6. Harmonics Test .....	27
7. Voltage Fluctuations-Flicker Test .....	28
7.1 Test Procedure .....	28
7.2 Test Equipment .....	28
7.3 Test result .....	29
8. Electrostatic Discharge Immunity Test .....	30

**TEST REPORT**

- 8.1 Purpose..... 30
- 8.2 Test Set-Up..... 30
- 8.3 Test Specification ..... 30
- 8.4 Test Equipment ..... 30
- 8.5 Test Result..... 31
  
- 9. Radiated, Radio-Frequency, Electromagnetic Field Immunity Test..... 34
  - 9.1 Purpose..... 34
  - 9.2 Test Set-Up..... 34
  - 9.3 Test Specification ..... 35
  - 9.4 Test Equipment ..... 35
  - 9.5 Generation of the Electromagnetic Field ..... 36
  - 9.6 Test Results ..... 36
  
- 10. Electrical Fast Transient/Burst Immunity Test ..... 37
  - 10.1 Purpose..... 37
  - 10.2 Test Set-Up..... 37
  - 10.3 Test Specification ..... 37
  - 10.4 Test Equipment ..... 38
  - 10.5 Test Results ..... 38
  
- 11. Surge Immunity Test ..... 39
  - 11.1 Purpose..... 39
  - 11.2 Test Set-Up..... 39
  - 11.3 Test Specification ..... 39
  - 11.4 Test Equipment. .... 40
  - 11.5 Test Results ..... 40
    - 11.5.1 Main power ports..... 40
  
- 12. Immunity to Conducted Disturbances, Inducted by Radio-Frequency Fields..... 41
  - 12.1 Purpose..... 41
  - 12.2 Test Set-Up..... 41
  - 12.3 Test Specification ..... 42
  - 12.4 Test Equipment..... 42
  - 12.5 Generation and Calibration of the Disturbance Signal..... 43
  - 12.6 Test Results ..... 43
  
- 13. Power Frequency Magnetic Field Immunity Test ..... 44
  - 13.1 Purpose..... 44
  - 13.2 Test Set-Up..... 44
  - 13.3 Test Condition..... 44
  - 13.4 Test Equipment. .... 45
  - 13.5 Test Result..... 45
  
- 14. Voltage Dips, Short Interruptions and Voltage Variations Immunity Test..... 46
  - 14.1 Purpose..... 46
  - 14.2 Test Set-Up..... 46
  - 14.3 Test Specification ..... 46
  - 14.4 Test Equipment..... 47

**TEST REPORT**

14.5 Generation of the Disturbance Signal ..... 47

14.6 Test Result..... 47

Appendix A: Uncertainty ..... 48

Appendix B1: External photo of EUT ..... 49

Appendix B2: Internal photo of EUT ..... 53

Appendix C1: Conducted Emission Test Set-up ..... 58

Appendix C2: ISN Test Set-up ..... 59

Appendix C3: Radiated Emission Test Set-up (Below 1GHz) ..... 60

Appendix C4: Radiated Emission Test Set-up (Above 1GHz) ..... 61

Appendix C5: Harmonics\ Flicker Test Set-up..... 62

Appendix C6: ESD Test Set-up..... 63

Appendix C7: RS Test Set-up..... 64

Appendix C8: EFT Signal Test Set-up..... 65

Appendix C9: EFT\ Surge\Dip Test Set-up ..... 66

Appendix C10: CS Test Set-up..... 67

Appendix C11: Power Frequency Magnetic Field Immunity Test Set-up ..... 68

## 1. General Information

### 1.1 Identification of the EUT

<b>Product:</b>	MTC-7000 Series Multi-touch panel pc
<b>Model No.:</b>	MTC-7010W
<b>Rated Power:</b>	DC 24 V from adapter
<b>Power Cord:</b>	3 C × 0.75 mm <sup>2</sup> × 2 meter unshielded cable
<b>Sample receiving date:</b>	May 22, 2020
<b>Sample condition:</b>	Workable
<b>Testing date:</b>	May 22, 2020 ~ Jun. 04, 2020

### 1.2 Adapter information

The EUT will be supplied with a power supply from below list:

No.	Model no.	Specification
Adapter	FSP120-AABN2	INPUT: 100-240Vac, 50-60Hz, 1.8A OUTPUT: 24Vdc, 5.0A, 120W

### 1.3 Additional information about the EUT

The customer confirmed MTC-7XXX-XXX is a series model to MTC-7010W (EUT), the different model numbers are served as marketing strategy.

For model: MTC-7XXX-XXX

The customer confirmed denote of "X" in model number as 0~9, A~Z, or blank for marketing purpose.

## 2. Test Summary

Emission			
Standard	Test Type	Result	Remarks
EN 55032: 2015/AC: 2016	Conducted Emission	PASS	Meet Class B Limit
	ISN	PASS	Meet Class B Limit
	Radiated Emission	PASS	Meet Class B Limit
EN IEC 61000-3-2: 2019	Harmonic current Emissions	N/A	The active input power is lower than 75W
EN 61000-3-3: 2013+A1: 2019	Voltage fluctuation & Flicker	PASS	Meet the requirements

Immunity (EN 55035: 2017)				
Standard	Test Type	Performance Criteria	Result	
IEC 61000-4-2: 2008	ESD	Criterion B	PASS	Meets the requirements of Performance Criterion A
IEC 61000-4-3: 2006 +AMD1:2007+AMD2:2010	RS	Criterion A	PASS	Meets the requirements of Performance Criterion A
IEC 61000-4-4: 2012	EFT	Criterion B	PASS	Meets the requirements of Performance Criterion A
IEC 61000-4-5: 2014/AMD1: 2017	Surge	Criterion B	PASS	Meets the requirements of Performance Criterion A
IEC 61000-4-6: 2013	CS	Criterion A	PASS	Meets the requirements of Performance Criterion A
IEC 61000-4-8: 2009	Magnetic Field	Criterion A	PASS	Meets the requirements of Performance Criterion A
IEC 61000-4-11:2004+AMD1:2017	Dip	1. >95% reduction- Criterion B 2. 30% reduction- Criterion C	PASS	Meets the requirements of Voltage Dips:  1. >95% reduction- Criterion A 2. 30% reduction- Criterion A
	Interruption	3. >95% reduction- Criterion C	PASS	3. >95% reduction- Criterion C

Note: Please note that the test results with statement of conformity, the decision rules which are based on: Safety Testing: the specification, standard or IEC Guide 115.

Other Testing: the specification, standard and not taking into account the measurement uncertainty.



### 3. Test Specifications

#### 3.1 Standards

**EN 55032: 2015/AC: 2016** Electromagnetic compatibility of multimedia equipment - Emission requirements

**EN IEC 61000-3-2: 2019** Electromagnetic compatibility (EMC) - Part 3-2: Limits - Limits for harmonic current emissions (equipment input current ≤16 A per phase)

**EN 61000-3-3: 2013+A1: 2019** Electromagnetic compatibility (EMC) - Part 3-3: Limits - Limitation of voltage changes, voltage fluctuations and flicker in public low-voltage supply systems, for equipment with rated current ≤ 16 A per phase and not subject to conditional connection

**EN 55035: 2017** Electromagnetic compatibility of multimedia equipment. Immunity requirements

#### 3.2 Test Facility accreditation

Intertek Testing Services Taiwan Ltd., Hsinchu Laboratory is accredited in respect of laboratory and the accreditation criterion is ISO/IEC 17025.

Certification	Bureau	Code	Accreditation Criteria
Accreditation Certificate	TAF	0597	ISO/IEC 17025
	BSMI	SL2-IS-E-0024 SL2-IN-E-0024 SL2-A1-E-0024 SL2-R2-E-0024 SL2-R1-E-0024 SL2-L1-E-0024	ISO/IEC 17025
Site Filling Code :	FCC	93910	Test facility list & NSA Data
	IC	2042D-1, 2042D-2	Test facility list & NSA Data
	VCCI	R-1534 C-1618 T-11586 G-10049	Test facility list & NSA Data

### 3.3 Classification of MME

The MME equipment defines Class A equipment and Class B equipment associated with two types of end-use environment.

The Class B requirements for equipment are intended to offer adequate protection to broadcast services within the residential environment.

Equipment intended primarily for use in a residential environment shall meet the Class B limits. All other equipment shall comply with the Class A limits.

Broadcast receiver equipment is class B equipment.

### 3.4 Performance criteria

The performance criteria listed below are based on those regulated in the standard.

#### Criteria A:

The equipment shall continue to operate as intended without operator intervention. No degradation of performance, loss of function or change of operating state is allowed below a performance level specified by the manufacturer when the equipment is used as intended. The performance level may be replaced by a permissible loss of performance. If the minimum performance level or the permissible performance loss is not specified by the manufacturer, then either of these may be derived from the product description and documentation, and by what the user may reasonably expect from the equipment if used as intended.

#### Criteria B:

During the application of the disturbance, degradation of performance is allowed. However, no unintended change of actual operating state or stored data is allowed to persist after the test.

After the test, the equipment shall continue to operate as intended without operator intervention; no degradation of performance or loss of function is allowed, below a performance level specified by the manufacturer, when the equipment is used as intended.

The performance level may be replaced by a permissible loss of performance.

If the minimum performance level (or the permissible performance loss), or recovery time, is not specified by the manufacturer, then either of these may be derived from the product description and documentation, and by what the user may reasonably expect from the equipment if used as intended.

**TEST REPORT**

Criteria C:

Loss of function is allowed, provided the function is self-recoverable, or can be restored by the operation of the controls by the user in accordance with the manufacturer’s instructions. A reboot or re-start operation is allowed.

Information stored in non-volatile memory, or protected by a battery backup, shall not be lost.

**3.5 Mode of operation during the test**

The EUT was supplied with 230Vac, 50Hz.

- (1) The EUT was setup in full load condition.
- (2) Ethernet port 1 & 2 connected to the WAP.
- (3) Power ON EUT, executed “ping command” at EUT & WAP & Notebook PC and connected each other.
- (4) EUT executed "Burn in" & Play color bar.
- (5) Start test.

**3.6 Peripherals equipment**

Peripherals	Brand	Model No.	Serial No.	Description of Data Cable
Notebook PC	HP	HSTNN-Q96C	5CD8021S9J	N/A
Monitor	DELL	P2210t	CN-OR945K-744 45-0BA-588S	1. Shielded Display cable 1.8meter 2. Shielded DVI cable 1.5 meter
Wirless AP	BUFFALO	WZR-AGL300NH	N/A	Unshielded RJ-45 cable 6 meter
Keyboard	ViewSonic	VS10230	P80053802065	N/A
Mouse	HP	M-UAE96	N/A	N/A
USB 3.0 Dongle	Kingston	DTSE9G2/8GB	PR180707B003 589-0000288	N/A
USB 3.0 Dongle	Kingston	DTSE9G2/8GB	PR180707B003 589-0000090	N/A
RS232 dummy load X2	Apple	MT531TA/A	F85LG24QF196	N/A

## 4. Conducted Emission Test

### 4.1 Test Procedure

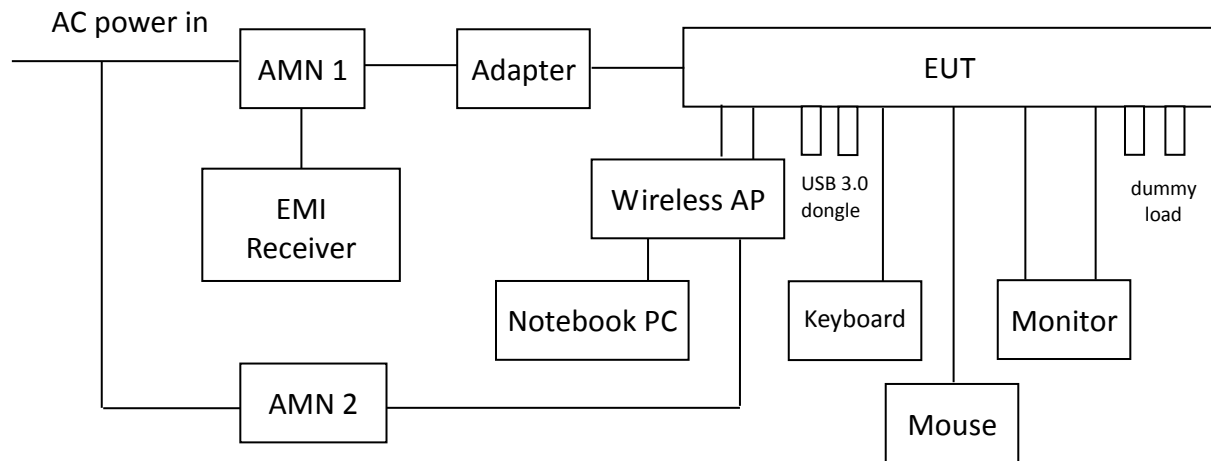

The EUT along with its peripherals were placed on a 1.0 meter(W)×1.5meter(L) and 0.8 meter in height wooden table and the EUT was adjusted to maintain a 0.4meter space from a vertical reference plane. The EUT was connected to power mains through a Artificial Mains Network (AMN), which provided 50 ohm coupling impedance for measuring instrument and the chassis ground was bounded to the horizontal ground plane of shielded room.

The excess power cable between the EUT and the AMN was banded. All connecting cables of EUT and peripherals were moved to find the maximum emission

#### 4.2 Test Equipment

Test Equipment/ Test site	Brand	Model No.	Serial No.	Calibration Date	Next Calibration Date
EMI Test Receiver	R&S	ESR7	101822	2019/06/19	2020/06/17
LISN	R&S	ENV216	101160	2019/07/17	2020/07/15
LISN	R&S	ESH3-Z5	835239/023	2019/09/23	2020/09/21
CON-2 Cable	SUHNER	EMCCFD300-B M-NM-6000	170502	2020/04/30	2021/04/29
Test software	Audix	e3	V4.20040112 L	NCR	NCR

Note: No Calibration Required (NCR).

#### 4.3 Conducted Emission Limit

Frequency (MHz)	Maximum RF Line Voltage	
	Class A Equipment (dB $\mu$ V)	
	Q.P.	Avg.
0.15~0.50	79	66
0.50~5.00	73	60
5.00~30.0	73	60

## TEST REPORT

### 4.4 Conducted Emission Data

Phase:	Live Line			
Temperature:	24	°C	Model No.:	MTC-7010W
Relative Humidity:	58	%	Test Date:	May 29, 2020
Atmospheric Pressure:	1008	hPa	Remark:	N/A

Frequency (MHz)	Corr. Factor (dB)	Reading QP (dBuV)	Level QP (dBuV)	Limit QP (dBuV)	Reading AV (dBuV)	Level AV (dBuV)	Limit AV (dBuV)	Margin (dB)	
								QP	AV
0.426	9.78	39.57	49.35	79.00	33.93	43.71	66.00	-29.65	-22.29
0.459	9.79	39.55	49.34	79.00	33.65	43.44	66.00	-29.66	-22.56
0.617	9.80	34.16	43.96	73.00	26.37	36.17	60.00	-29.04	-23.83
0.963	9.81	32.05	41.86	73.00	22.00	31.81	60.00	-31.14	-28.19
1.367	9.82	33.15	42.97	73.00	20.64	30.46	60.00	-30.03	-29.54
1.772	9.83	31.09	40.91	73.00	25.28	35.11	60.00	-32.09	-24.89
2.133	9.83	27.64	37.48	73.00	20.66	30.50	60.00	-35.52	-29.50

Remark:

1. Corr. Factor (dB) = AMN Factor (dB) + Cable Loss (dB)
2. Level (dBuV) = Corr. Factor (dB) + Reading (dBuV)
3. Margin (dB) = Level (dBuV) – Limit (dBuV)

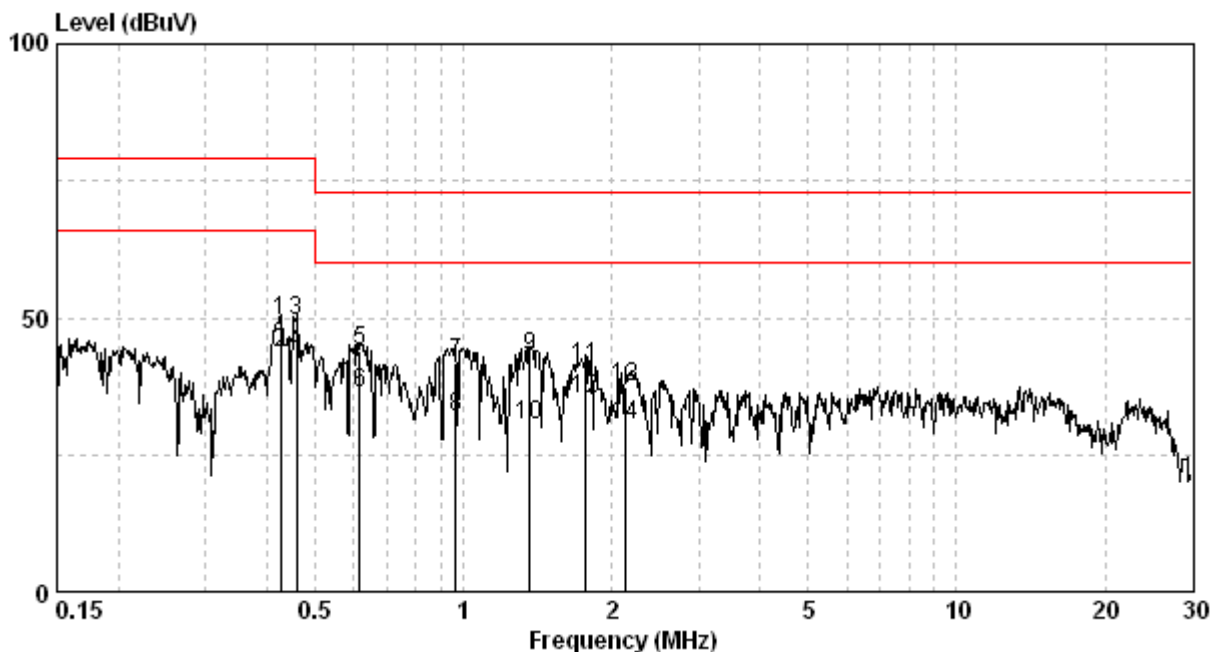

## TEST REPORT

Phase:	Neutral Line			
Temperature:	24	°C	Model No.:	MTC-7010W
Relative Humidity:	58	%	Test Date:	May 29, 2020
Atmospheric Pressure:	1008	hPa	Remark:	N/A

Frequency (MHz)	Corr. Factor (dB)	Reading QP (dBuV)	Level QP (dBuV)	Limit QP (dBuV)	Reading AV (dBuV)	Level AV (dBuV)	Limit AV (dBuV)	Margin (dB)	
								QP	AV
0.428	9.78	36.87	46.65	79.00	34.75	44.53	66.00	-32.35	-21.47
0.459	9.79	40.26	50.05	79.00	34.89	44.68	66.00	-28.95	-21.32
0.604	9.81	33.01	42.82	73.00	24.19	34.00	60.00	-30.18	-26.00
1.049	9.82	31.91	41.73	73.00	22.21	32.03	60.00	-31.27	-27.97
1.381	9.83	33.32	43.15	73.00	27.27	37.10	60.00	-29.85	-22.90
1.772	9.84	30.59	40.43	73.00	24.32	34.16	60.00	-32.57	-25.84

Remark:

1. Corr. Factor (dB) = AMN Factor (dB) + Cable Loss (dB)
2. Level (dBuV) = Corr. Factor (dB) + Reading (dBuV)
3. Margin (dB) = Level (dBuV) – Limit (dBuV)

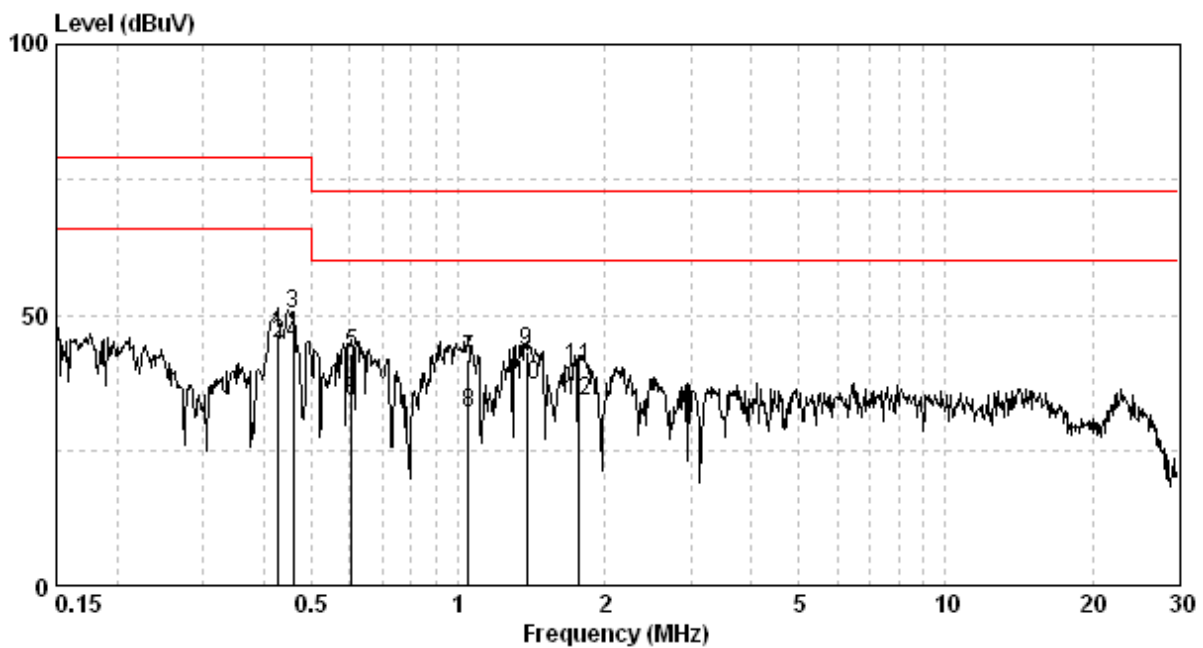

### 4.5 Telecommunication Port Emission Test

#### 4.5.1 Test Procedure

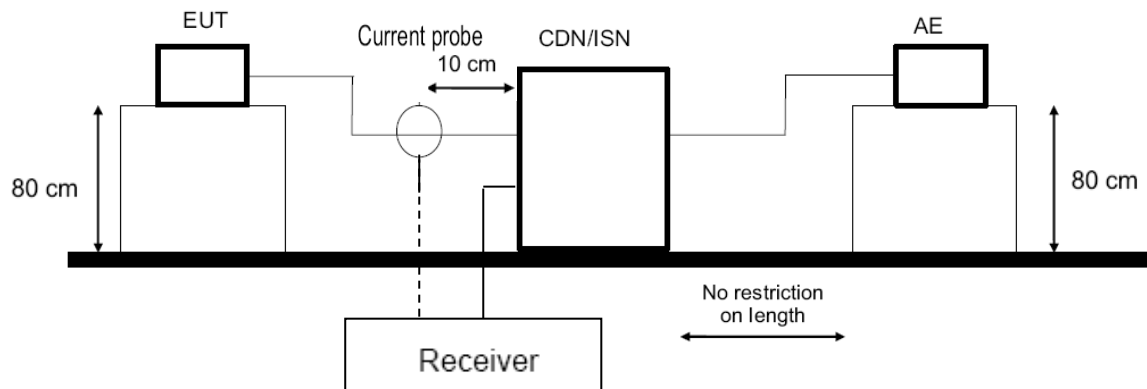

#### 4.5.2 Test Equipment

Test Equipment/ Test site	Brand	Model No.	Serial No.	Calibration Date	Next Calibration Date
EMI Receiver	R&S	ESCI	100059	2019/11/05	2020/11/03
Two-Line V-Network	R&S	ENV216	101159	2019/06/12	2020/06/10
ISN	TESEQ	ISN T8	24556	2020/05/24	2021/05/23
LISN	R&S	ESH3-Z5	835239/023	2019/09/23	2020/09/21
CON-2 Cable	SUHNER	EMCCFD300-BM-NM-6000	170502	2020/04/30	2021/04/29
Test software	Audix	e3	V4.20040112L	NCR	NCR

Note: No Calibration Required (NCR).



**4.5.3 Limits of conducted common mode (asymmetric mode) disturbance at telecommunication ports**

Frequency (MHz)	Voltage limits	
	Class A Equipment (dB $\mu$ V)	
	Q.P.	Avg.
0.15~0.50	97 to 87	84 to 74
0.50~30.00	87	74

## TEST REPORT

### 4.5.4 Telecommunication Port Emission Data

Test port:	ISN 1Gbps			
Temperature:	24	°C	Model No.:	MTC-7010W
Relative Humidity:	58	%	Test Date:	May 29, 2020
Atmospheric Pressure:	1008	hPa	Remark:	N/A

Frequency (MHz)	Corr. Factor (dB)	Reading QP (dBuV)	Level QP (dBuV)	Limit QP (dBuV)	Reading AV (dBuV)	Level AV (dBuV)	Limit AV (dBuV)	Margin (dB)	
								QP	AV
0.739	9.79	38.45	48.24	87.00	32.81	42.60	74.00	-38.76	-31.40
1.403	9.74	44.79	54.53	87.00	37.93	47.66	74.00	-32.47	-26.34
1.725	9.72	43.55	53.28	87.00	37.35	47.07	74.00	-33.72	-26.93
2.225	9.71	43.61	53.32	87.00	37.79	47.50	74.00	-33.68	-26.50
4.598	9.71	44.93	54.64	87.00	37.19	46.90	74.00	-32.36	-27.10
8.235	9.73	41.95	51.68	87.00	35.02	44.75	74.00	-35.32	-29.25

Remark:

1. Corr. Factor (dB) = ISN Factor (dB) + Cable Loss (dB)
2. Level (dBuV) = Corr. Factor (dB) + Reading (dBuV)
3. Margin (dB) = Level (dBuV) – Limit (dBuV)

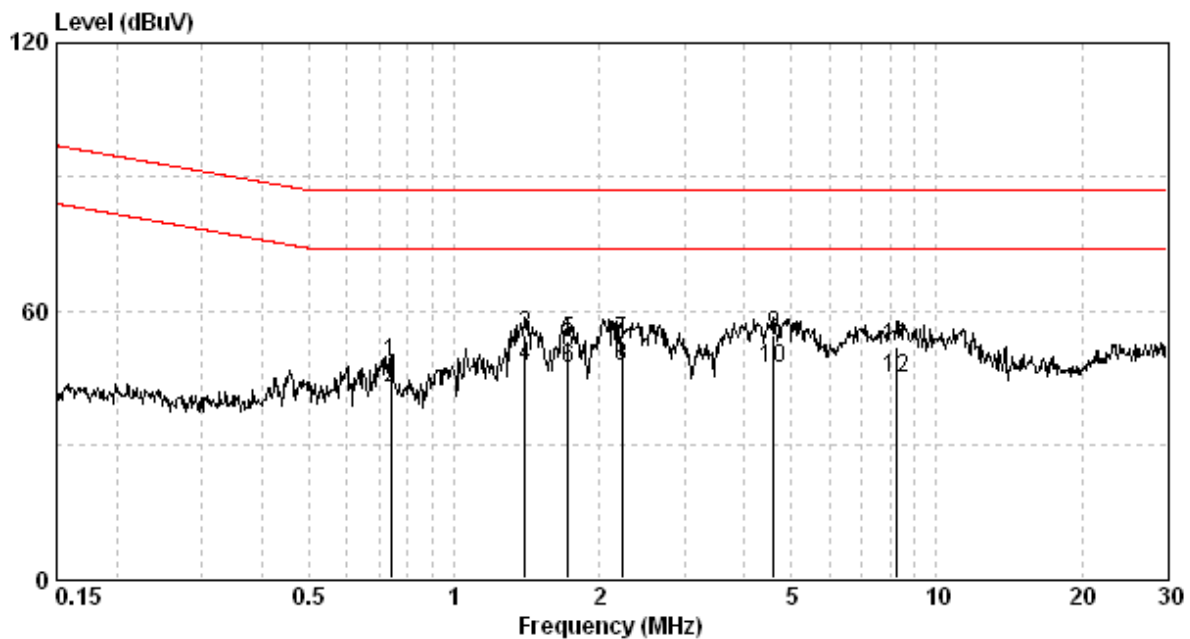

## 5. Radiated Emission Test

### 5.1.1 Test Procedure from 30 MHz to 1000 MHz

The figure below shows the test setup, which is utilized to make these measurements.

Side View

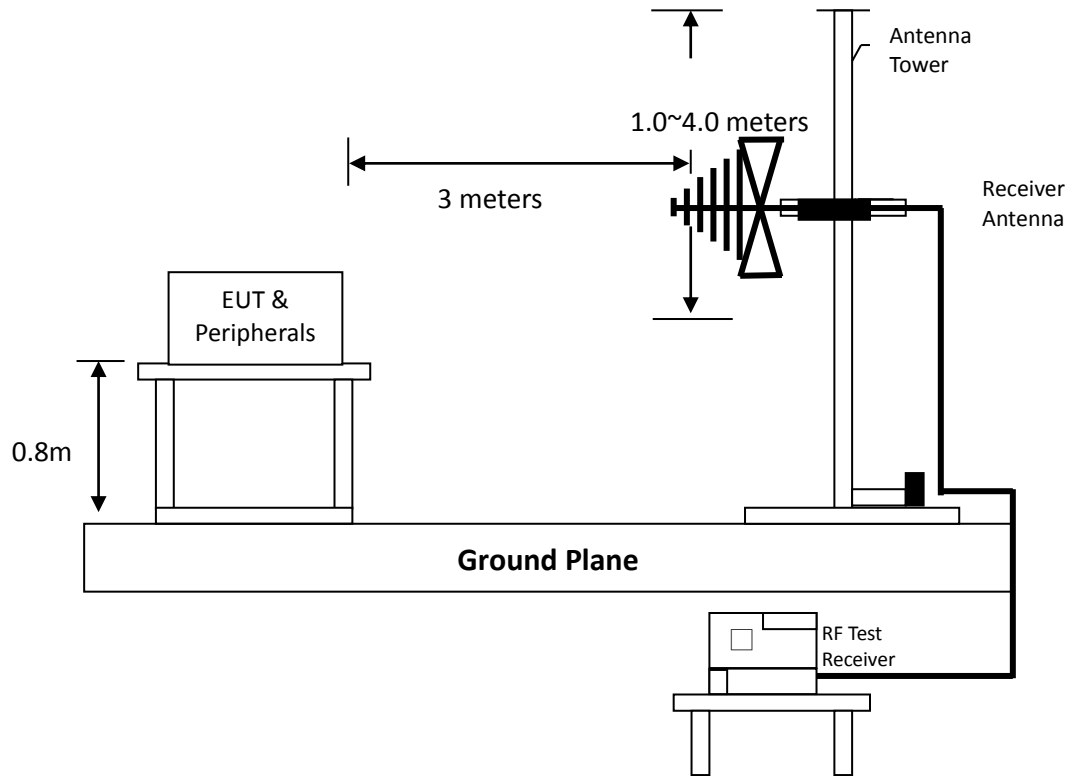

Top View

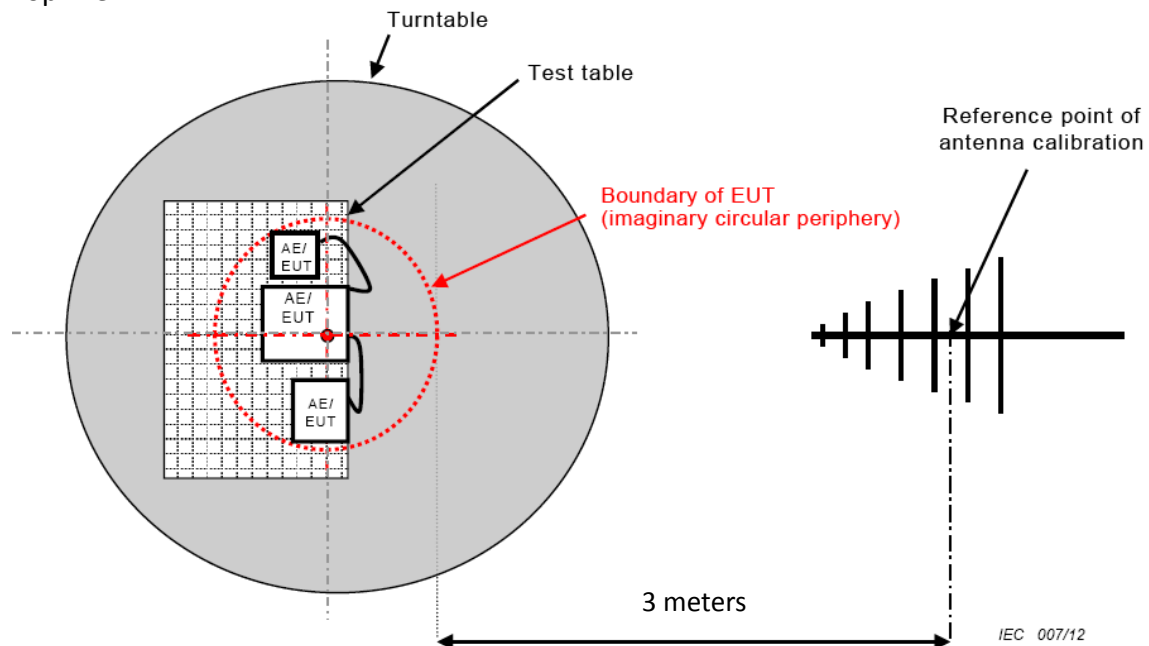

**TEST REPORT**

Radiated testing was performed at a 3 meters semi-anechoic chamber. The equipment under test were placed on a turntable top 0.8 meter above ground. The table was 360 degrees to determine the position of the highest radiation. EUT is set 3 meters from the EMI receiving antenna, which is mounted on a variable height mast. The antenna height is varied between one meter and four meters above ground to find the maximum value of the field strength. Both horizontal polarization and vertical polarization of the antenna was set to conduct the measurement.

The bandwidth was set on the EMI meter 120 kHz.

The levels are quasi peak value readings. The frequency spectrum from 30 MHz to 1000 MHz was investigated.

**5.1.2 Test Equipment**

Test Equipment/ Test site	Brand	Model No.	Serial No.	Calibration Date	Next Calibration Date
EMI Test Receiver	R&S	ESU40	100381	2019/06/05	2020/06/03
Bi-log Hybrid Antenna	ETC	MCTD2786	BL13S03017	2019/06/27	2020/06/25
966-1(A) Cable	SUHNER	SMA / SUCOFLEX 104	29510614	2020/04/13	2021/04/12
966-1(B) Cable	JUNFLON	SMA / J12J100880-00	AUG-26-08-001	2020/04/13	2021/04/12
966-1_3m Semi-Anechoic Chamber	966_1	CEM-966_1	N/A	2020/03/02	2021/03/01
Test software	Audix	e3	V4.20040112L	NCR	NCR

Note: No Calibration Required (NCR).

**5.1.3 Radiated Emission Limit**

<b>Frequency (MHz)</b>	<b>Distance(m)</b>	<b>Class A Equipment (dB<math>\mu</math>V/m)</b>
30~230	3	50
230~1000	3	57

Note:

1. The tighter limit shall apply at the edge between two frequency bands.
2. Distance refers to the distance in meters between the EUT to antenna.

## TEST REPORT

### 5.1.4 Radiated Emission Test Data from 30 MHz to 1000 MHz

Polarity:	Vertical			
Temperature:	24	°C	Model No.:	MTC-7010W
Relative Humidity:	55	%	Test Date:	May 28, 2020
Atmospheric Pressure:	1008	hPa	Remark:	N/A

Freq	Pol/Phase	Factor	Read Level	Level	Limit Line	Over Limit	Remark
MHz		dB	dB $\mu$ V	dB $\mu$ V/m	dB $\mu$ V/m	dB	
32.910	VERTICAL	24.75	16.90	41.65	50.00	-8.35	QP
117.300	VERTICAL	17.81	22.44	40.25	50.00	-9.75	QP
475.230	VERTICAL	26.22	24.69	50.90	57.00	-6.10	QP
521.790	VERTICAL	27.26	20.48	47.75	57.00	-9.25	QP
594.540	VERTICAL	27.90	23.33	51.22	57.00	-5.78	QP
714.820	VERTICAL	29.71	22.68	52.39	57.00	-4.61	QP
952.470	VERTICAL	33.53	17.99	51.51	57.00	-5.49	QP

Remark:

1. Factor = Antenna Factor (dB/m) + Cable Loss (dB)
2. Level (dB $\mu$ V/m) = Factor (dB) + Read Level (dB $\mu$ V)
3. Over Limit (dB) = Level (dB $\mu$ V/m) – Limit Line (dB $\mu$ V/m)

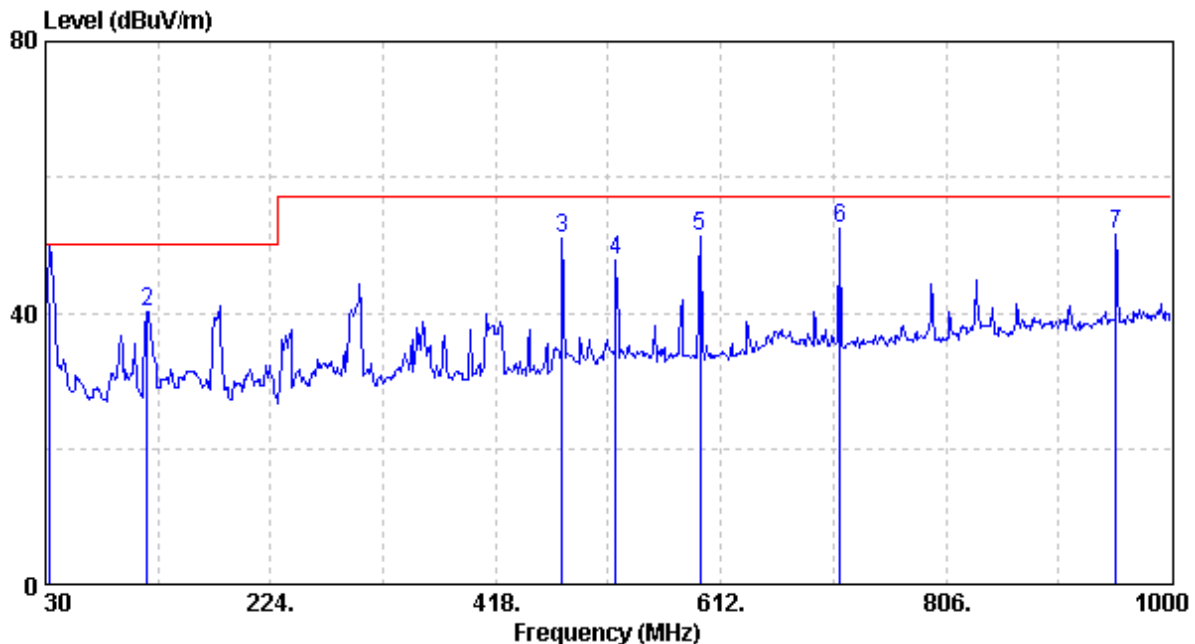

## TEST REPORT

Polarity:	Horizontal			
Temperature:	24	°C	Model No.:	MTC-7010W
Relative Humidity:	55	%	Test Date:	May 28, 2020
Atmospheric Pressure:	1008	hPa	Remark:	N/A

Freq	Pol/Phase	Factor	Read Level	Level	Limit Line	Over Limit	Remark
MHz		dB	dBμV	dBμV/m	dBμV/m	dB	
94.990	HORIZONTAL	16.10	19.77	35.86	50.00	-14.14	QP
180.350	HORIZONTAL	17.08	20.63	37.71	50.00	-12.29	QP
354.950	HORIZONTAL	23.93	17.91	41.84	57.00	-15.16	QP
475.230	HORIZONTAL	26.22	21.16	47.37	57.00	-9.63	QP
594.540	HORIZONTAL	27.90	18.51	46.41	57.00	-10.59	QP
714.820	HORIZONTAL	29.71	14.35	44.07	57.00	-12.93	QP
952.470	HORIZONTAL	33.53	22.12	55.65	57.00	-1.36	QP

Remark:

1. Factor = Antenna Factor (dB/m) + Cable Loss (dB)
2. Level (dBμV/m) = Factor (dB) + Read Level (dBμV)
3. Over Limit (dB) = Level (dBμV/m) – Limit Line (dBμV/m)

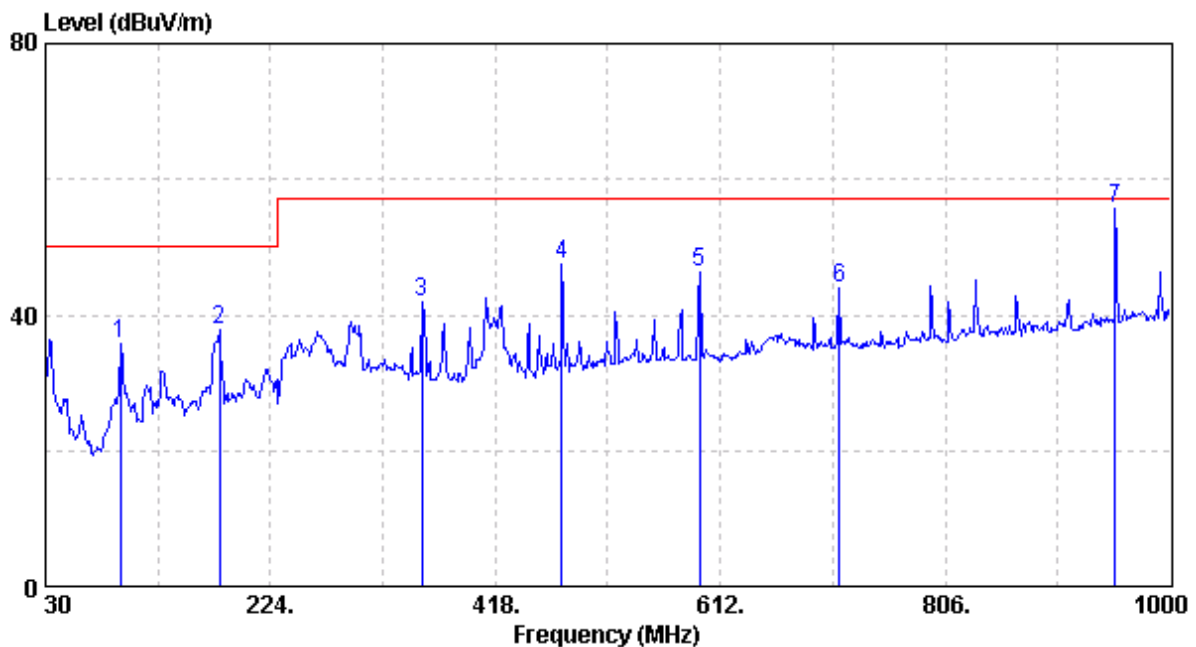

**5.2.1 Test Procedure above 1 GHz**

The figure below shows the test setup, which is utilized to make these measurements.

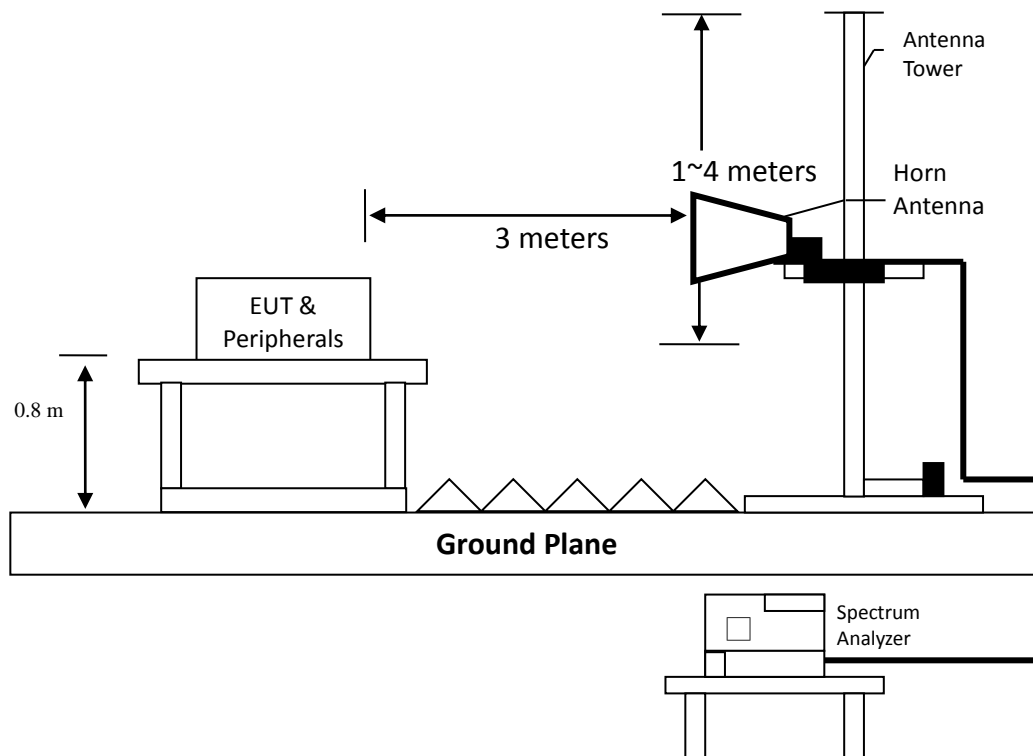

Radiated testing was performed at a 3 meters semi-anechoic chamber. The equipment under test were placed on a turntable top 0.8 meter above ground. The table was 360 degrees to determine the position of the highest radiation. EUT is set 3 meters from the EMI receiving antenna, which is mounted on a variable height mast. The antenna height is varied between one meter and four meters above ground to find the maximum value of the field strength. Both horizontal polarization and vertical polarization of the antenna was set to conduct the measurement.

The bandwidth was set on the EMI meter 1 MHz.

The levels are peak and average value readings. The frequency spectrum above 1 GHz was investigated.



### 5.2.2 Test Equipment

Test Equipment	Brand	Model No.	Serial No.	Calibration Date	Next Calibration Date
EMI Test Receiver	R&S	ESU40	100381	2020/05/29	2021/05/28
Horn Antenna	EMCO	3115	9906-5822	2020/05/07	2021/05/06
Pre-Amplifier	SCHWARZBECK	BBV9718	9718-004	2019/10/16	2020/10/14
966-1(A) Cable	SUHNER	SMA / SUCOFLEX 104	29510614	2020/04/13	2021/04/12
966-1(B) Cable	JUNFLON	SMA / J12J100880-00	AUG-26-08-001	2020/04/13	2021/04/12
966-1_3m Semi-Anechoic Chamber	966_1	CEM-966_1	N/A	2020/03/02	2021/03/01
Test software	Audix	e3	V4.2004011 2L	NCR	NCR

Note: No Calibration Required (NCR).

### 5.2.3 Radiated Emission Limit

Frequency (GHz)	Distance (meter)	Class A Equipment	
		Average limit (dB $\mu$ V/m)	Peak limit (dB $\mu$ V/m)
1 ~ 3	3	56	76
3 ~ 6	3	60	80

Note: The lower limit applies at the transition frequency.

## TEST REPORT

### 5.2.4 Radiated Emission Test Data above 1 GHz

Polarity:	Vertical			
Temperature:	24	°C	Model No.:	MTC-7010W
Relative Humidity:	55	%	Test Date:	Jun. 03, 2020
Atmospheric Pressure:	1008	hPa	Remark:	N/A

Freq	Pol/Phase	Factor	Read Level	Level	Limit Line	Over Limit	Remark
MHz		dB	dBuV	dBuV/m	dBuV/m	dB	
1065.000	VERTICAL	-12.09	63.71	51.62	76.00	-24.38	Peak
1185.000	VERTICAL	-11.18	73.55	62.37	76.00	-13.63	Peak
1185.000	VERTICAL	-11.18	67.00	55.82	56.00	-0.18	Average
1325.000	VERTICAL	-11.48	60.74	49.26	76.00	-26.74	Peak
1590.000	VERTICAL	-9.99	57.47	47.48	76.00	-28.52	Peak
1785.000	VERTICAL	-8.07	55.63	47.55	76.00	-28.45	Peak
2120.000	VERTICAL	-6.40	56.02	49.62	76.00	-26.38	Peak
2410.000	VERTICAL	-4.32	58.88	54.56	76.00	-21.44	Peak
3000.000	VERTICAL	-1.46	46.91	45.45	76.00	-30.55	Peak

Remark:

1. Level (dBuV/m) = Factor (dB) + Read Level (dBuV)
2. Factor = Antenna Factor (dB/m) + Cable Loss (dB) – Amplifier Gain (dB)  
(\*The Amplifier Gain depended on measure equipment, see test equipment list.)
3. Over Limit (dB) = Level (dBuV/m) – Limit Line (dBuV/m)

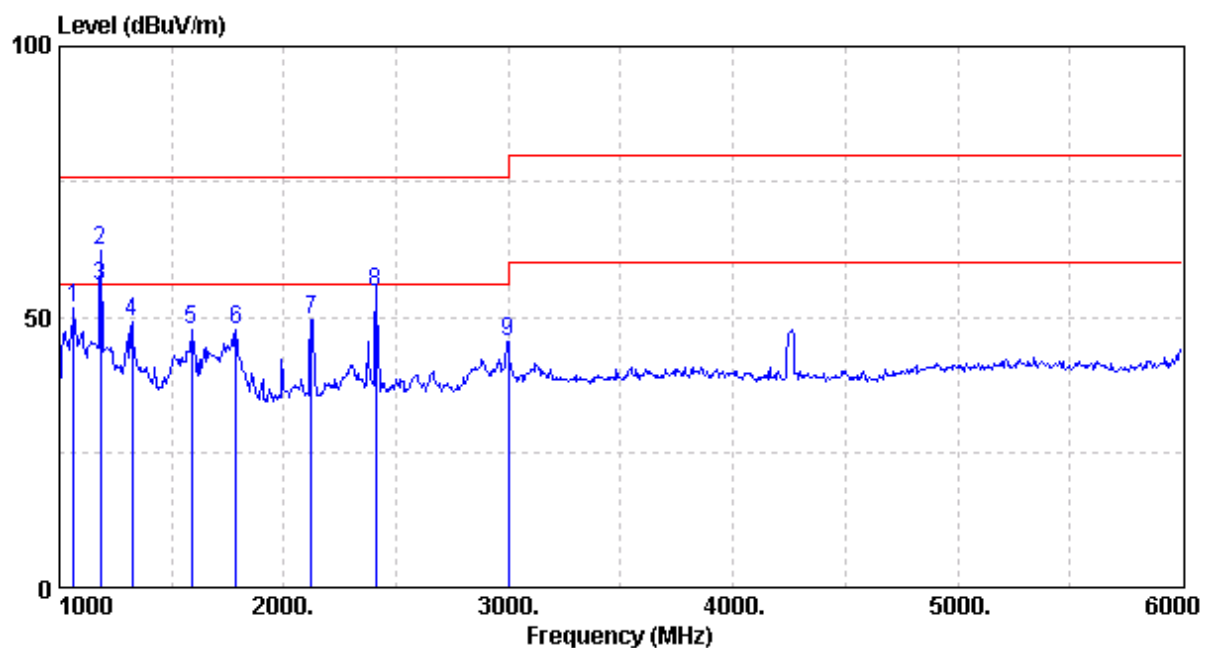

## TEST REPORT

Polarity:	Horizontal			
Temperature:	24	°C	Model No.:	MTC-7010W
Relative Humidity:	55	%	Test Date:	Jun. 03, 2020
Atmospheric Pressure:	1008	hPa	Remark:	N/A

Freq	Pol/Phase	Factor	Read Level	Level	Limit Line	Over Limit	Remark
MHz		dB	dBuV	dBuV/m	dBuV/m	dB	
1065.000	HORIZONTAL	-12.09	58.84	46.74	76.00	-29.26	Peak
1185.000	HORIZONTAL	-11.18	66.02	54.85	76.00	-21.15	Peak
1325.000	HORIZONTAL	-11.48	62.64	51.16	76.00	-24.84	Peak
1590.000	HORIZONTAL	-9.99	61.23	51.24	76.00	-24.76	Peak
1785.000	HORIZONTAL	-8.07	54.33	46.26	76.00	-29.74	Peak
2120.000	HORIZONTAL	-6.40	53.90	47.50	76.00	-28.50	Peak
2410.000	HORIZONTAL	-4.32	51.45	47.13	76.00	-28.87	Peak
2655.000	HORIZONTAL	-3.43	50.09	46.66	76.00	-29.34	Peak

Remark:

1. Level (dBuV/m) = Factor (dB) + Read Level (dBuV)
2. Factor = Antenna Factor (dB/m) + Cable Loss (dB) – Amplifier Gain (dB)  
(\*The Amplifier Gain depended on measure equipment, see test equipment list.)
3. Over Limit (dB) = Level (dBuV/m) – Limit Line (dBuV/m)

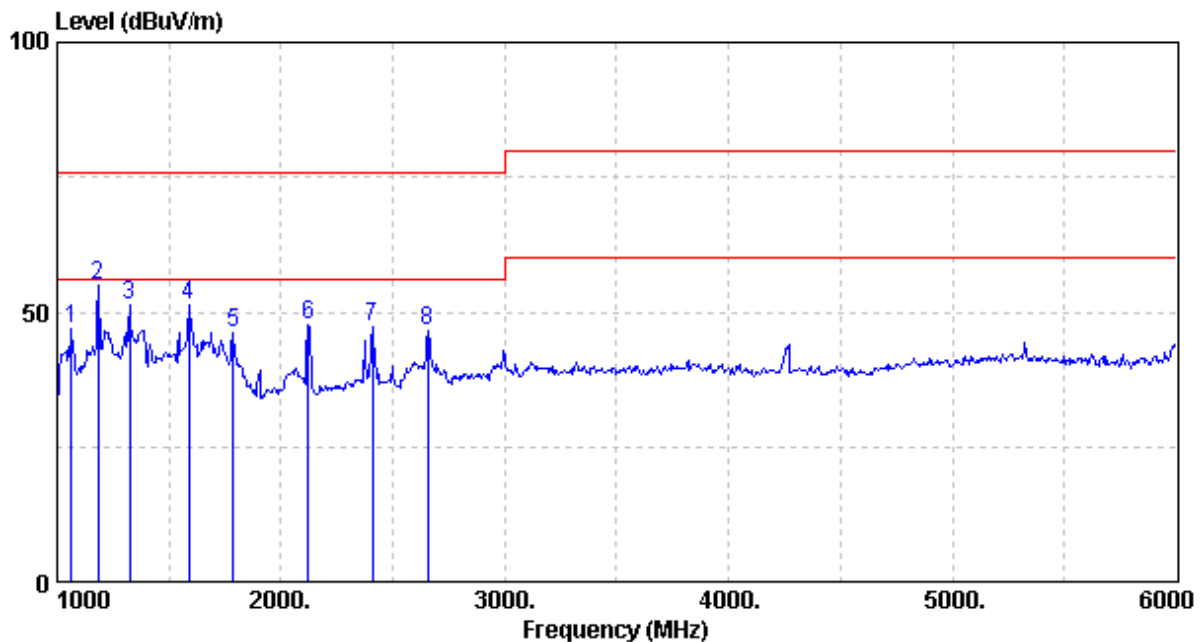

**6. Harmonics Test****P = 26.6 Watt**

According to the EN61000-3-2 requirement for rated power of all applications, there are no limits apply for equipment with an active input power up to and including 75W. For class A equipment, if the active input power is lower than 75W, the equipment shall not be tested.

## 7. Voltage Fluctuations-Flicker Test

### 7.1 Test Procedure

The voltage changes at the supply terminals were measured using the voltage method.

The test voltage was supplied from an AC source which meets the requirements according to the standard. The voltage source has virtually zero internal impedance and is connected

(1 phase)

$Z = 0.4 + j 0.25\Omega$  (total impedance)

(3 phases)

Impedance in line conductor:  $Z_a = 0.25 + j 0.25 \Omega$

Impedance in neutral conductor:  $Z_n = 0.15 + j 0.10 \Omega$

The observation period,  $T_P$ , for the assessment of flicker values by flicker measurement, flicker simulation, or analytical method shall be:

- for  $P_{st}$ ,  $T_P = 10$  min
- for  $P_{it}$ ,  $T_P = 2$  h

The observation period shall include that part of the whole operation cycle in which the equipment under test produces the most unfavorable sequence of voltage changes.

24 measurements have been taken and calculated the average from 22 records, exclude highest and lowest.

### 7.2 Test Equipment

Test Equipment/ Test site	Brand	Model No.	Serial No.	Calibration Date	Next Calibration Date
Harmonic/ Flick Test System	TESEQ	Proflin 2105	1537A00781	2019/11/07	2020/11/05
Test software	AMETEK	Win2100	V4.23	NCR	NCR

Note: No Calibration Required (NCR).

**7.3 Test result**

**SUMMARY RESULT:        PASS**

Temperature:	24	°C	Model No.:	MTC-7010W
Relative Humidity:	53	%	Test Date:	Jun. 02, 2020
Atmospheric Pressure:	1004	hPa	Remark:	N/A

	<b>EUT DATA</b>	<b>LIMIT</b>	<b>RESULT</b>	<b>TEST ENABLED</b>
<b>T-max (mS)</b>	<b>0</b>	<b>500.0</b>	<b>PASS</b>	<input checked="" type="checkbox"/>
<b>Highest dc (%)</b>	<b>0.00</b>	<b>3.30</b>	<b>PASS</b>	<input checked="" type="checkbox"/>
<b>d<sub>max</sub> %</b>	<b>0.40</b>	<b>4.00</b>	<b>PASS</b>	<input checked="" type="checkbox"/>
<b>Highest Pst</b>	<b>0.092</b>	<b>1.000</b>	<b>PASS</b>	<input checked="" type="checkbox"/>
<b>Highest Plt</b>	<b>0.058</b>	<b>0.650</b>	<b>PASS</b>	<input checked="" type="checkbox"/>

## 8. Electrostatic Discharge Immunity Test

### 8.1 Purpose

The object of the test is to evaluate the ESD immunity performance of EUT.

### 8.2 Test Set-Up

A horizontal coupling plane (HCP) was placed on a non-metallic table 0.8 meter above a reference ground plane (RGP) and connected to it with a cable with two 470 k $\Omega$  resistors. The EUT was placed on an insulation sheet on the HCP and was operated according to the specified operating mode.

A vertical coupling plane (VCP) was connected to the RGP with a cable with two 470 k $\Omega$  resistors.

### 8.3 Test Specification

Test level:    Air discharge                    -----       +/- 8 kV  
                  Contact discharge                -----       +/- 4 kV

Single discharge at 1 second interval positive discharge and negative discharge  
The selected test points are listed in this table, the numbers refer to the figures attached.

### 8.4 Test Equipment

Test Equipment/ Test site	Brand	Model No.	Serial No.	Calibration Date	Next Calibration Date
Electrostatic Discharge System	NoiseKen	ESS-2002	ESS0291088	2019/08/17	2020/08/15

## 8.5 Test Result

Temperature:	24	°C	Model No.:	MTC-7010W
Relative Humidity:	52	%	Test Date:	Jun. 04, 2020
Atmospheric Pressure:	1003	hPa	Remark:	N/A

Point of Discharge	Applied Voltage (kV)	Number of Discharge	Test Result	Performance Criterion
Contact Test Point	±2	20	PASS	A
	±4	20	PASS	A
Air Test Point	±2	20	PASS	A
	±4	20	PASS	A
	±8	20	PASS	A
VCP (4 sides)	±2	25	PASS	A
	±4	25	PASS	A
HCP (4 sides)	±2	25	PASS	A
	±4	25	PASS	A

### Description of Discharge Point

Contact Discharge <u>15</u> Test points		Air Discharge	
<input checked="" type="checkbox"/>	Metallic Screws	<input type="checkbox"/>	Plastic Screws
<input checked="" type="checkbox"/>	Metallic Case	<input type="checkbox"/>	Plastic Case (gap)
<input checked="" type="checkbox"/>	Metallic Connect ports	<input type="checkbox"/>	Plastic Connect ports
<input checked="" type="checkbox"/>	Metallic Junctions	<input type="checkbox"/>	Plastic Junctions
<input type="checkbox"/>	Others:	<input type="checkbox"/>	LED indicator
		<input checked="" type="checkbox"/>	Panel Board
		<input type="checkbox"/>	Others:



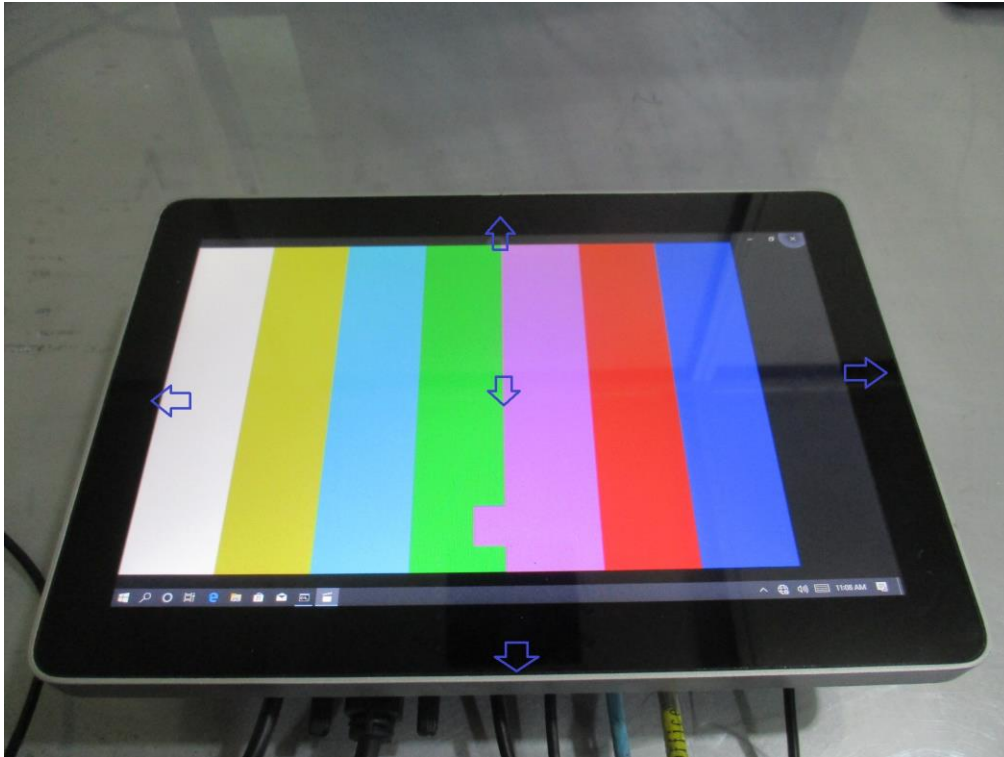



## 9. Radiated, Radio-Frequency, Electromagnetic Field Immunity Test

### 9.1 Purpose

This test method subjects the EUT to a power source of disturbance comprising electric and magnetic field, simulating those coming from intentional RF transmitters.

### 9.2 Test Set-Up

The EUT was placed on a non-metallic table 0.8 meter above the reference ground plane (RGP) and was operated according to its specified operating mode.

Ferrite tiles/absorbers were placed on the RGP between the EUT and the antenna to reduce the reflections from the RGP. The EUT and its cables were exposed for the electromagnetic field for 1.5meter vertically and 1.5m horizontally.

The distance between antenna and EUT is 3 meter.

For acoustic measurements on loudspeakers

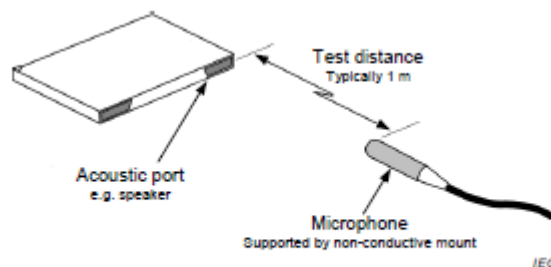

The microphone is connected via the cable to a suitable amplifier. Ensure that there is minimal acoustic loss between EUT and microphone.

For audio output port measurements

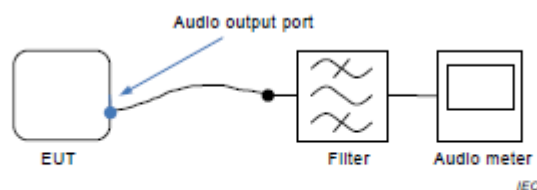

The filter is the audio filter specified in G.6.1 and is typically incorporated into the audio meter. Additional filtering might be necessary to ensure that the RF disturbance signal does not interfere with the measurement.

### 9.3 Test Specification

Frequency range	Test field strength V/m	Modulation
80MHz ~ 1GHz	3	1 kHz 80% AM
1800MHz ±1 %		
2600MHz ±1 %		
3500MHz ±1 %		
5000MHz ±1 %		

The frequency steps : 1 % , Log sweep

Dwell time : 3 sec

Test ports : Enclosure port

### 9.4 Test Equipment

Test Equipment/ Test site	Brand	Model No.	Serial No.	Calibration Date	Next Calibration Date
733 Compact Full Anechoic Chamber	Comtest	9708093	N/A	2019/09/12	2020/09/10
Signal Generator	R&S	SMB100A	102385	2020/02/17	2021/02/15
Field Meter	Narda	NBM-520	D-1426	2019/06/09	2022/06/07
Field Probe	Narda	EF0691	H-0199	2019/06/09	2022/06/07
Test software	Audix	i2	5.160923	NCR	NCR

Note: No Calibration Required (NCR).

### 9.5 Generation of the Electromagnetic Field

The electromagnetic field is generated from a computer controlled signal generator. The output power is amplified and then radiated from broadband log periodic antennas. For each sweep a pre-recorded empty chamber calibration file is used to establish the required field strength. When using these files the field strength inside an area of 1.5/1.0 meter x 1.5 meter is in accordance with the standard.

### 9.6 Test Results

Temperature:	24	°C	Model No.:	MTC-7010W
Relative Humidity:	52	%	Test Date:	Jun. 02, 2020
Atmospheric Pressure:	1003	hPa	Remark:	N/A

Exposed Side:  Front  Left  Rear  Right

Frequency	Antenna Polarization	Test Level	Test Result	Performance Criterion
80 MHz to 1 GHz	Vertical	3V/m	PASS	A
80 MHz to 1 GHz	Horizontal	3V/m	PASS	A
1800MHz ±1 %	Vertical	3V/m	PASS	A
1800MHz ±1 %	Horizontal	3V/m	PASS	A
2600MHz ±1 %	Vertical	3V/m	PASS	A
2600MHz ±1 %	Horizontal	3V/m	PASS	A
3500MHz ±1 %	Vertical	3V/m	PASS	A
3500MHz ±1 %	Horizontal	3V/m	PASS	A
5000MHz ±1 %	Vertical	3V/m	PASS	A
5000MHz ±1 %	Horizontal	3V/m	PASS	A

## 10. Electrical Fast Transient/Burst Immunity Test

### 10.1 Purpose

The purpose of this test is to evaluate the EUT performance during the repetitive transient bursts applied to power port and ports for I/O ports.

### 10.2 Test Set-Up

For I/O ports testing, the EUT was placed on a non-metallic support 0.1±0.01 meter above a reference ground plane (RGP) and operated in the operating mode specified.

Applicable only to cables which according to the manufacturer's specification supports communication on cable lengths greater than 3 meter.

### 10.3 Test Specification

Open-circuit output test voltage (±10%) and repetition rate of the impulses (±20%)				
Level	On power supply port, PE		On I/O (Input/Output) signal, Data and control ports	
	Voltage peak (kV)	Repetition rate (kHz)	Voltage peak (kV)	Repetition rate (kHz)
1	0.5	5 or 100	0.25	5 or 100
2	1	5 or 100	0.5	5 or 100
3	2	5 or 100	1	5 or 100
4	4	5 or 100	2	5 or 100
X <sup>(1)</sup>	Special	Special	Special	Special

NOTE 1 Use of 5 kHz repetition rates is traditional; however, 100 kHz is closer to reality. Product committees should determine which frequencies are relevant for specific products or product types.

NOTE 2 With some products, there may be no clear distinction between power ports and I/O ports, in which case it is up to product committees to make this determination for test purposes.

(1) "X" is an open level. The level has to be specified in the dedicated equipment specification

### 10.4 Test Equipment

Test Equipment/ Test site	Brand	Model No.	Serial No.	Calibration Date	Next Calibration Date
EMC Test System	TESEQ	NSG 3060	1366	2019/11/05	2020/11/03
CDN 3061	TESEQ	CDN 3061	1342	2019/11/05	2020/11/03
CDN 3063	TESEQ	CDN 3063	1992	2019/11/05	2020/11/03
EFT Clamp	TESEQ	CDN 3425	1682	2019/11/04	2020/11/02
Test software	TESEQ	WIN3000	1.1.0	NCR	NCR

Note: No Calibration Required (NCR).

### 10.5 Test Results

Temperature:	24	°C	Model No.:	MTC-7010W
Relative Humidity:	52	%	Test Date:	Jun. 03, 2020
Atmospheric Pressure:	1003	hPa	Remark:	N/A

Level	Polarity	Repetition Rate	Power supply port Test Result	Signal port & Control port Test Result (see Note 1)	Performance Criterion
0.5 kV	+	5 kHz	-	PASS	A
0.5 kV	-	5 kHz	-	PASS	A
1 kV	+	5 kHz	PASS	-	A
1 kV	-	5 kHz	PASS	-	A

Note 1: Signal Line and Control Line were tested for: Ethernet port

## 11. Surge Immunity Test

### 11.1 Purpose

The object of this test is to establish a common reference to evaluate the performance of EUT when subjected to high-energy disturbances on the power and interconnection lines.

### 11.2 Test Set-Up

The EUT was placed on a non-metallic support 0.8 meter above a reference ground plane and was put into operation according to the specified operating mode.

### 11.3 Test Specification

#### For power supply line

Level	Open circuit test voltage kV +/- 10%	Remark
1	0.5	L to N
2	1.0	L to N
3	2.0	L to Gnd N to Gnd
4	4.0	-
X	Special	-

Note: "X" is an open class. This level can be specified in the product specification

Surge wave form: 1.2 x 50  $\mu$ s, Repetition rate: 1 /min (max)



### 11.4 Test Equipment.

Test Equipment/ Test site	Brand	Model No.	Serial No.	Calibration Date	Next Calibration Date
EMC Test System	TESEQ	NSG 3060	1366	2019/11/05	2020/11/03
CDN 3061	TESEQ	CDN 3061	1342	2019/11/05	2020/11/03
CDN HSS-2	TESEQ	CDN HSS-2	38145	2019/11/04	2020/11/02
CDN 3063	Teseq	CDN 3063	1992	2019/11/05	2020/11/03
Test software	TESEQ	WIN3000	1.1.0	NCR	NCR

Note: No Calibration Required (NCR).

### 11.5 Test Results

#### 11.5.1 Main power ports

Temperature:	24	°C	Model No.:	MTC-7010W
Relative Humidity:	52	%	Test Date:	Jun. 03, 2020
Atmospheric Pressure:	1003	hPa	Remark:	N/A

Test 5 times for each voltage

Phase			Test Result				Performance Criterion
Volt	Mode	Polarity	0°	90°	180°	270°	
0.5 kV	L to N	+	PASS	PASS	PASS	PASS	A
		-	PASS	PASS	PASS	PASS	A
1 kV	L to N	+	PASS	PASS	PASS	PASS	A
		-	PASS	PASS	PASS	PASS	A
2 kV	L to Gnd	+	PASS	PASS	PASS	PASS	A
		-	PASS	PASS	PASS	PASS	A
	N to Gnd	+	PASS	PASS	PASS	PASS	A
		-	PASS	PASS	PASS	PASS	A

## 12. Immunity to Conducted Disturbances, Inducted by Radio-Frequency Fields

### 12.1 Purpose

The test method subjects the EUT to a power source of disturbance comprising electric and magnetic field, simulating those coming from intentional RF transmitters.

The measurement is for evaluating the performance of EUT when subjected to RF conducted disturbance.

### 12.2 Test Set-Up

The EUT was placed on a non-metallic support 0.1 meter above a reference ground plane (RGP) with the coupling/decoupling network (CDN) placed 0.3 meter from the EUT on the RGP.

For acoustic measurements on loudspeakers

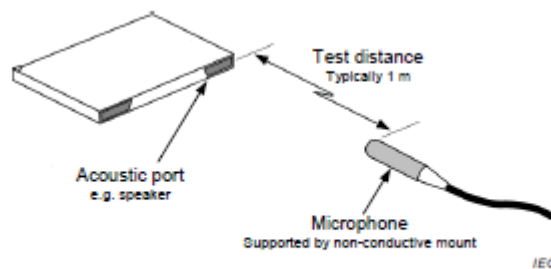

The microphone is connected via the cable to a suitable amplifier. Ensure that there is minimal acoustic loss between EUT and microphone.

For audio output port measurements

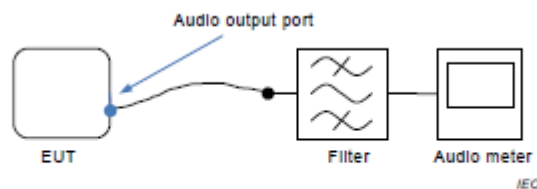

The filter is the audio filter specified in G.6.1 and is typically incorporated into the audio meter. Additional filtering might be necessary to ensure that the RF disturbance signal does not interfere with the measurement.

### 12.3 Test Specification

Frequency range (MHz)	Test Voltage (Vrms)	Modulation
0.15MHz ~ 10MHz	3	1 kHz 80 % AM
10MHz ~ 30MHz	3 ~ 1	1 kHz 80 % AM
30MHz ~ 80MHz	1	1 kHz 80 % AM

### 12.4 Test Equipment

Test Equipment/ Test site	Brand	Model No.	Serial No.	Calibration Date	Next Calibration Date
CS test system	TESEQ	NSG 4070B-35	41146	2019/08/26	2020/08/24
CDN	Schaffner	CDN M016	21272	2020/06/01	2021/05/31
CDN	Fischer	FCC-801-M2-16A	04017	2019/08/27	2020/08/25
Clamp	TESEQ	KEMZ 801A	41333	2019/08/27	2020/08/25
CDN	Fischer	FCC-801-M1-16A	04015	2019/08/27	2020/08/25
CDN	Fischer	FCC-801-T8-RJ45	08036	2019/08/27	2020/08/25
CDN	Schaffner	CDN T400	19096	2019/08/27	2020/08/25
Test software	TESEQ	NSG4070	V 1.2.0	NCR	NCR

Note: No Calibration Required (NCR)

### 12.5 Generation and Calibration of the Disturbance Signal

The disturbance signal is generated from a computer controlled signal generator. The output signal is amplified and injected to the CDN/injection clamp. The disturbance signal level was calibrated as specified in the standard. A power meter was connected to the EUT side of the CDN through a 150 -50Ω adapter. The auxiliary equipment (AE) side of the network was terminated with 150Ω to ground during the calibration. The generator settings obtained during the calibration procedure were later repeated in the tests.

### 12.6 Test Results

Temperature:	24	°C	Model No.:	MTC-7010W
Relative Humidity:	52	%	Test Date:	Jun. 02, 2020
Atmospheric Pressure:	1003	hPa	Remark:	N/A

Frequency	Test Port	Test Level	Test Result	Performance Criterion
0.15MHz ~ 10MHz	AC	3V	PASS	A
10MHz ~ 30MHz		3 ~ 1V	PASS	A
30MHz ~ 80MHz		1V	PASS	A
0.15MHz ~ 10MHz	Ethernet	3V	PASS	A
10MHz ~ 30MHz		3 ~ 1V	PASS	A
30MHz ~ 80MHz		1V	PASS	A

### 13. Power Frequency Magnetic Field Immunity Test

#### 13.1 Purpose

The measurement is for evaluating the performance of EUT, when subject to power frequency magnetic field disturbance.

#### 13.2 Test Set-Up

The EUT was placed on a wooden table above a reference RGP with the coupling loop antenna arrange the EUT on the RGP.

#### 13.3 Test Condition

Test levels for continuous field

Level	Magnetic field strength (A/m)
1	1
2	3
3	10
4	30
5	100
X <sup>(1)</sup>	Special
Note: 1. "x" is an open level. This level can be given in the product specification.	

Test levels for short duration: 1s to 3s

Level	Magnetic field strength (A/m)
1	n.a <sup>(2)</sup>
2	n.a <sup>(2)</sup>
3	n.a <sup>(2)</sup>
4	300
5	1000
X <sup>(1)</sup>	Special
Note: 1. "x" is an open level. This level, as well the duration of the test, can be given in this product specification. 2. "n.a" = not applicable	

### 13.4 Test Equipment.

Test Equipment/ Test site	Brand	Model No.	Serial No.	Calibration Date	Next Calibration Date
Magnetic test system	PMM	PMM1008	000J90601	2018/11/20	2020/11/18
Test software	PMM	PMM1008	V 1.19	NCR	NCR

Note: No Calibration Required (NCR).

### 13.5 Test Result

Temperature:	24	°C	Model No.:	MTC-7010W
Relative Humidity:	52	%	Test Date:	Jun. 03, 2020
Atmospheric Pressure:	1003	hPa	Remark:	230 Vac, 50/60Hz

Continuous Field (50 or 60 Hz)					Short Duration				
Level	H.Field (A/m)	X	Y	Z	Level	H.Field (A/m)	X	Y	Z
		Performance Criterion					Performance Criterion		
1	1	A	A	A	1	N/A	-	-	-
2	3	-	-	-	2	N/A	-	-	-
3	10	-	-	-	3	N/A	-	-	-
4	30	-	-	-	4	300	-	-	-
5	100	-	-	-	5	1000	-	-	-
X	Special	-	-	-	X	Special	-	-	-

Note: 1. “-” means not applicable  
 2. Magnetic field ambient level: <0.01 mG

**TEST REPORT**

**14. Voltage Dips, Short Interruptions and Voltage Variations Immunity Test**

**14.1 Purpose**

The object of this standard is to establish a common reference for evaluating the immunity of electrical and electronic equipment when subjected to voltage dips, short interruptions, and voltage variations.

**14.2 Test Set-Up**

The EUT was placed on a non-metallic support 0.8 meter above a reference ground plane and was put into operation according to the specified operating mode.

**14.3 Test Specification**

**For 50 Hz**

Test Level	Reduction % of rated	Test Level % U <sub>T</sub>	Duration Period	Tests	Recovery Time(Sec)
1	>95%	<5%	0.5	3	10
2	30%	70%	25	3	10
3	>95%	<5%	250	3	10

**For 60Hz**

Test Level	Reduction % of rated	Test Level % U <sub>T</sub>	Duration Period	Tests	Recovery Time(Sec)
1	>95%	<5%	1	3	10
2	30%	70%	30	3	10
3	>95%	<5%	300	3	10

**TEST REPORT**

**14.4 Test Equipment**

Test Equipment/ Test site	Brand	Model No.	Serial No.	Calibration Date	Next Calibration Date
Advanced EMC Immunity Test System	Keytek	EMC Pro	9807103	2019/10/29	2020/10/27
Test software	KeyTek	CEWare 32	4.00	NCR	NCR

Note: No Calibration Required (NCR).

**14.5 Generation of the Disturbance Signal**

The disturbance signal is generated using a programmable AC power source with pre-programmed test sequences for each test.

**14.6 Test Result**

Temperature:	24	°C	Model No.:	MTC-7010W
Relative Humidity:	52	%	Test Date:	Jun. 03, 2020
Atmospheric Pressure:	1003	hPa	Remark:	100/230 Vac, 50 Hz

Test Level	Reduction % of rated	Test Level (% U <sub>T</sub> )	Duration Period	Tests	Recovery Time(Sec)	Performance Criterion
1	>95 %	<5 %	0.5	3	10	A
2	30 %	70 %	25	3	10	A
3	>95 %	<5 %	250	3	10	C

Temperature:	24	°C	Model No.:	MTC-7010W
Relative Humidity:	52	%	Test Date:	Jun. 03, 2020
Atmospheric Pressure:	1003	hPa	Remark:	100/230 Vac, 60 Hz

Test Level	Reduction % of rated	Test Level (% U <sub>T</sub> )	Duration Period	Tests	Recovery Time(Sec)	Performance Criterion
1	>95 %	<5 %	1	3	10	A
2	30 %	70 %	30	3	10	A
3	>95 %	<5 %	300	3	10	C



### Appendix A: Uncertainty

This uncertainty represents an expanded uncertainty expressed at approximately the 95% confidence level using a coverage factor of k=2.

Item	Uncertainty
Conducted disturbance measurements at a mains port from 9 kHz to 30 MHz using a 50 Ω/50 μH +5Ω artificial mains network (AMN)	2.52 dB
Conducted disturbance measurements at a telecommunication port from 150 kHz to 30 MHz using an asymmetrical artificial network (AAN)	4.02 dB
Vertically polarized radiated disturbances from 30MHz~1GHz in a open area test site at a distance of 10m	4.90 dB
Horizontally polarized radiated disturbances from 30MHz~1GHz in a open area test site at a distance of 10m	4.89 dB
Vertically polarized radiated disturbances from 30MHz~1GHz in a semi-anechoic chamber at a distance of 3m	5.10 dB
Horizontally polarized radiated disturbances from 30MHz~1GHz in a semi-anechoic chamber at a distance of 3m	5.18 dB
Radiated disturbances measurements from 1GHz~6GHz in a semi-anechoic chamber at a distance of 3m	4.96 dB
The measured induced current density due to the electric field from 20 kHz~10MHz	1.60 dB
HARMONIC	0.15 %
FLICKER	0.10 %
ESD	7.18 %
RS	2.20 dB
RS (Audio)	1.49 dB
EFT	6.20 %
SURGE	5.60 %
CS	1.06 dB
CS (Audio)	1.18 dB
Mag.	1.00 %
DIP	1.60 %
Ring Wave	5.50 %
Immunity to low-frequency signals	0.17 %

**Appendix B1: External photo of EUT**

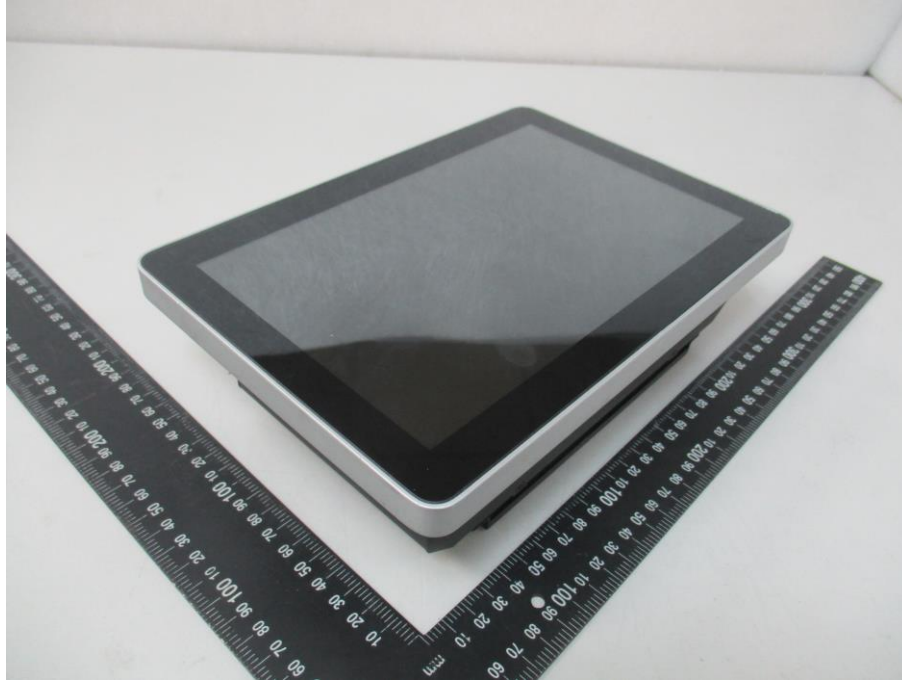







## Appendix B2: Internal photo of EUT









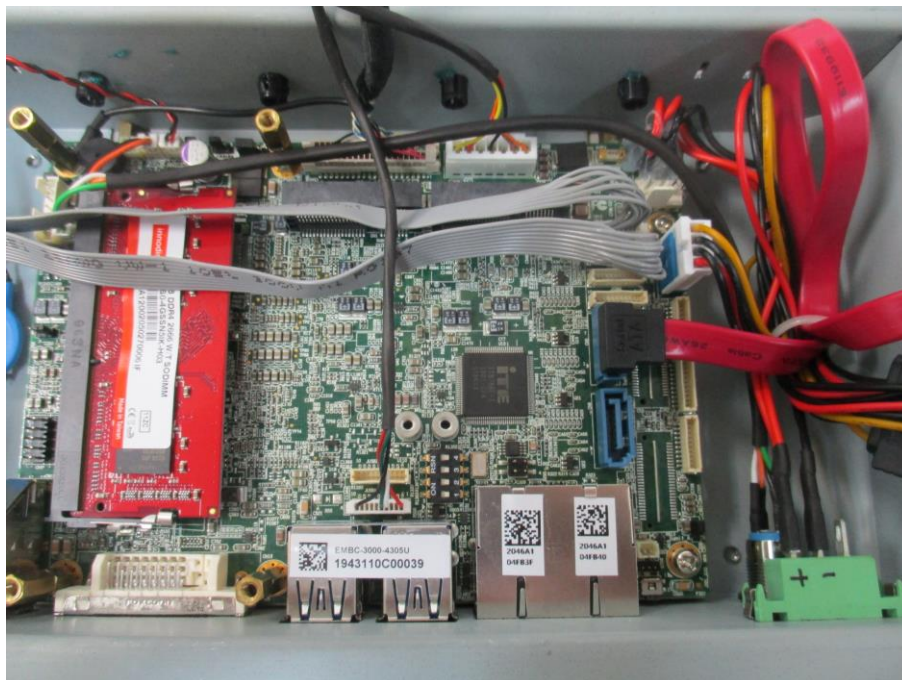



**Appendix C1: Conducted Emission Test Set-up**

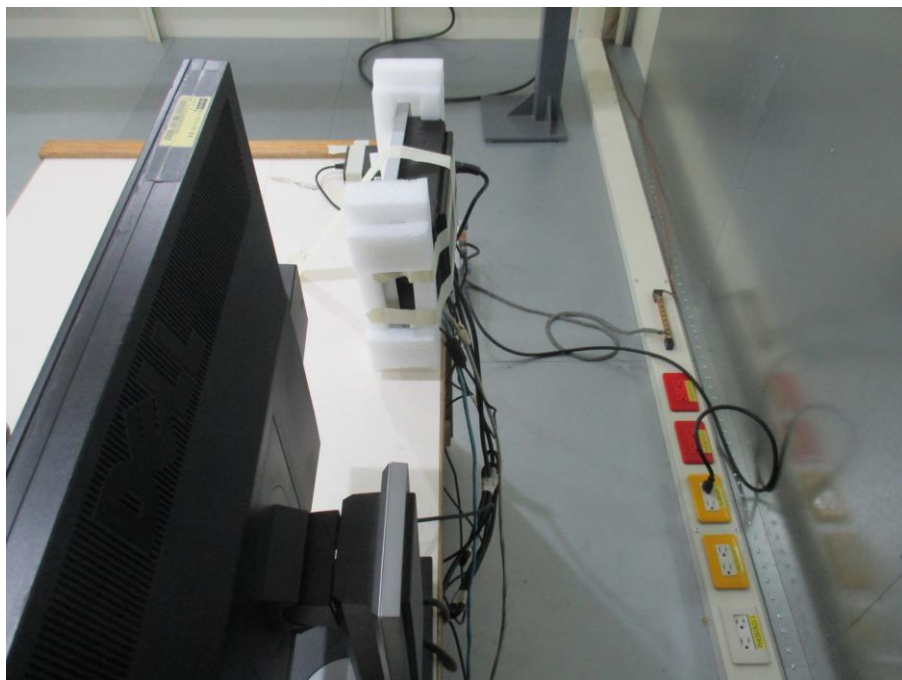

**Appendix C2: ISN Test Set-up**

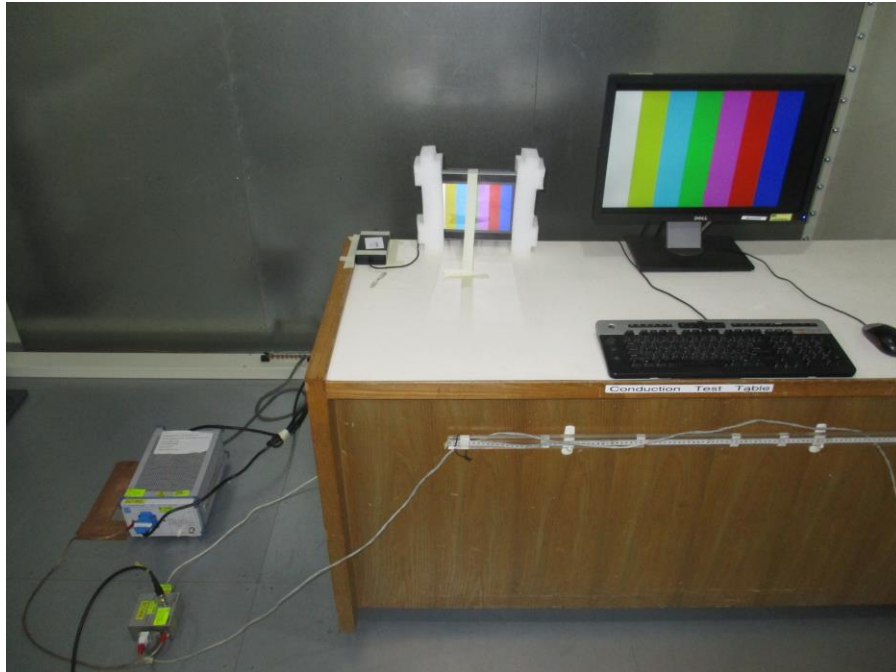

**Appendix C3: Radiated Emission Test Set-up (Below 1GHz)**

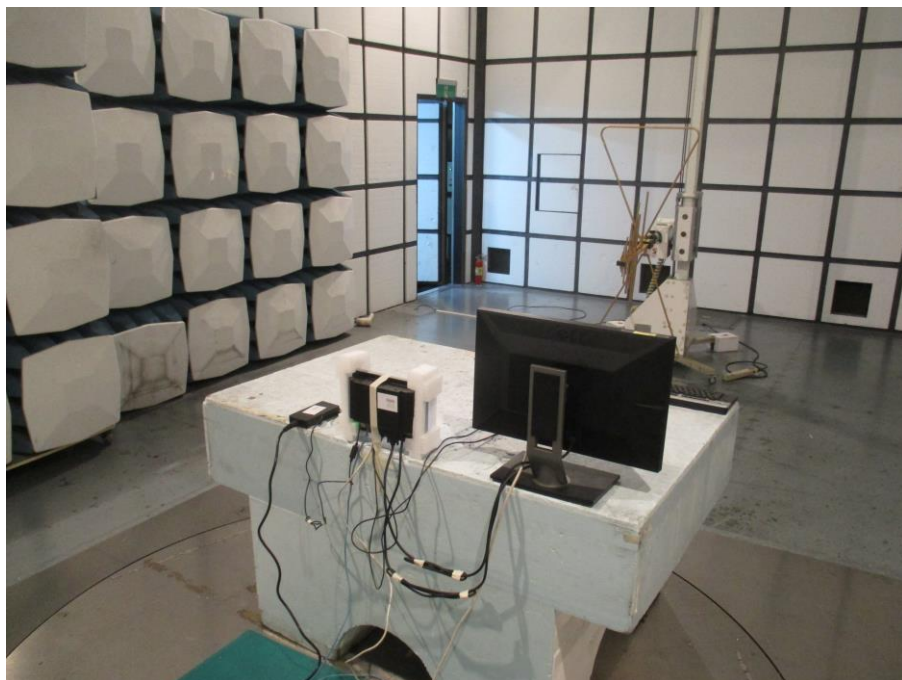
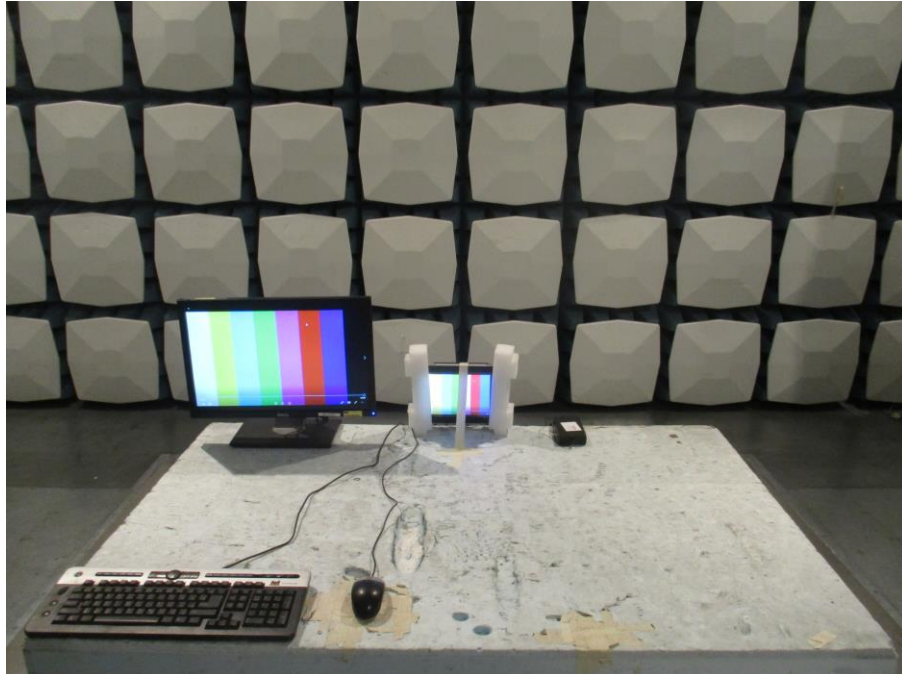

## Appendix C4: Radiated Emission Test Set-up (Above 1GHz)

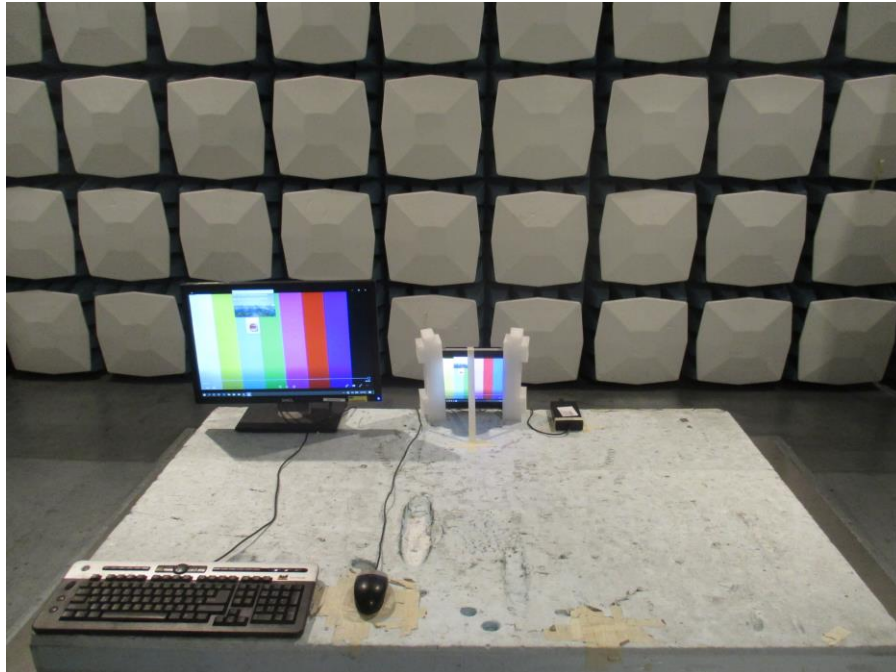

## Appendix C5: Harmonics\ Flicker Test Set-up



**Appendix C6: ESD Test Set-up**





**Appendix C7: RS Test Set-up**

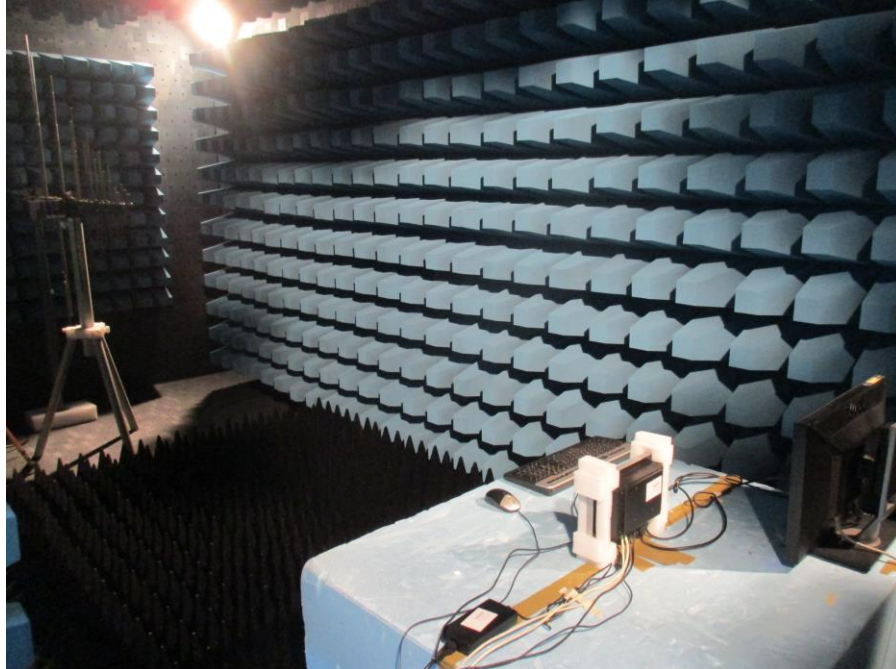

## Appendix C8: EFT Signal Test Set-up



## Appendix C9: EFT\ Surge\Dip Test Set-up



## Appendix C10: CS Test Set-up

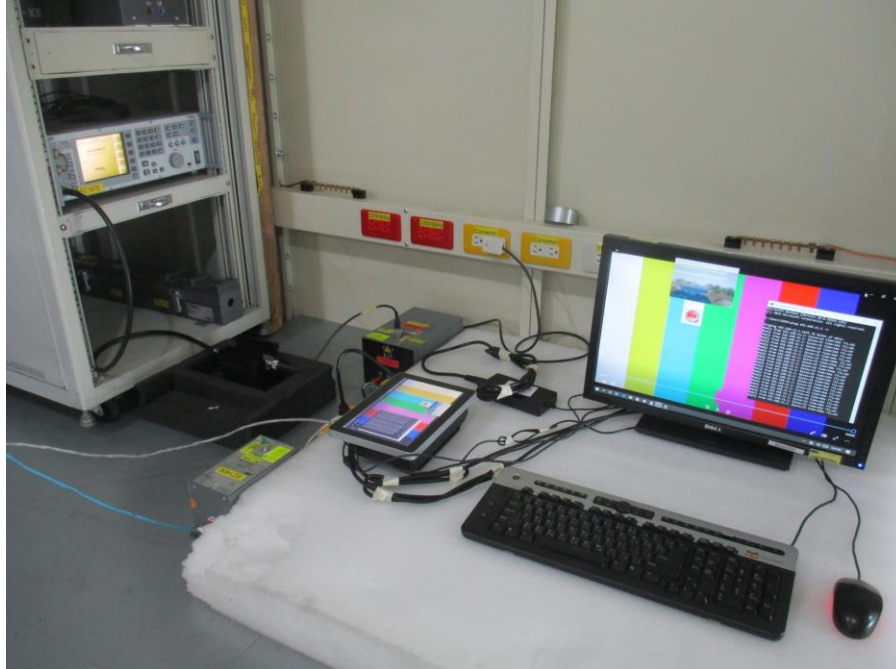

**Appendix C11: Power Frequency Magnetic Field Immunity Test Set-up**

